

INCASSO CERNIERA SUPERIORE

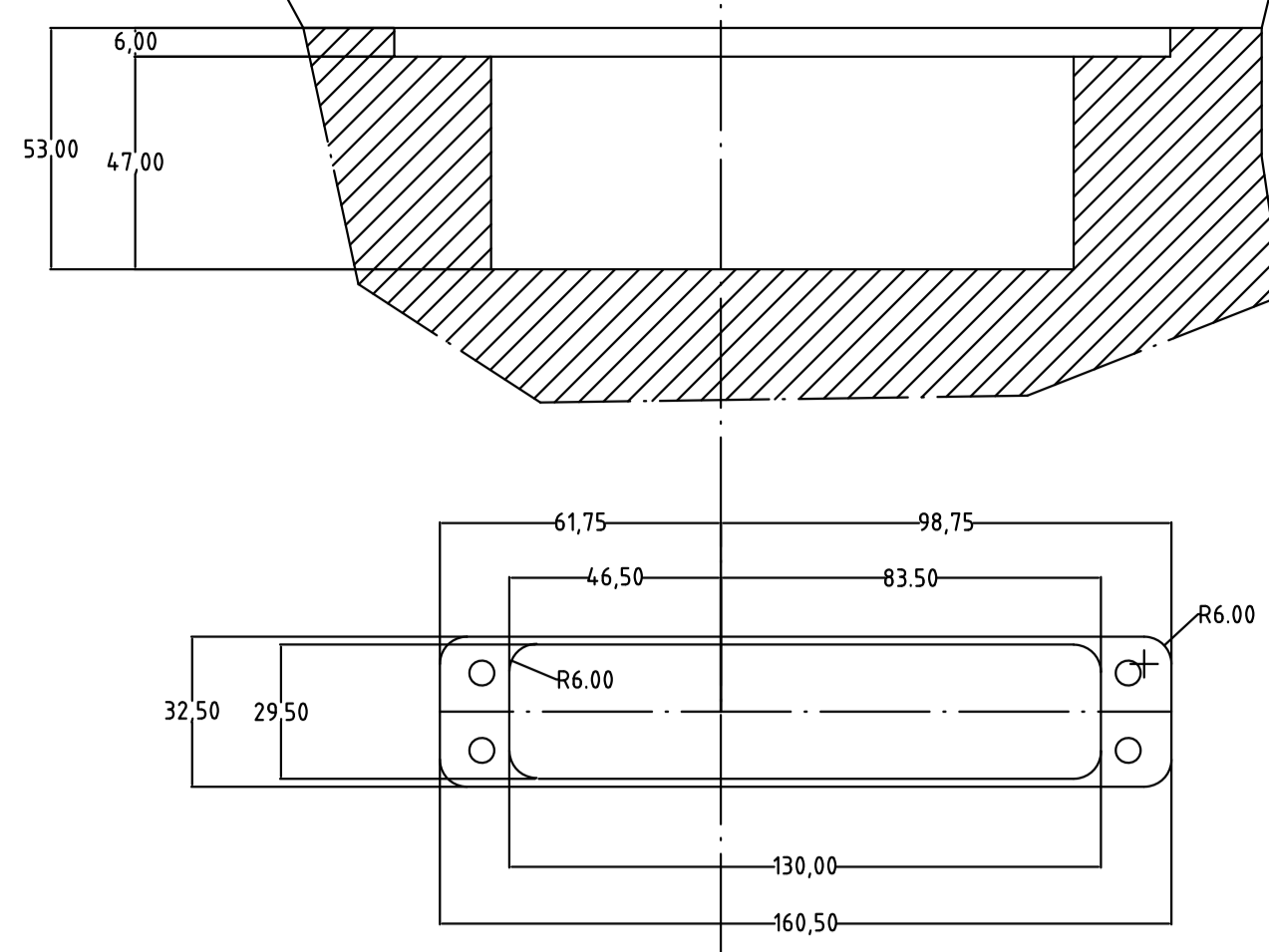

9901 SUPERIORE

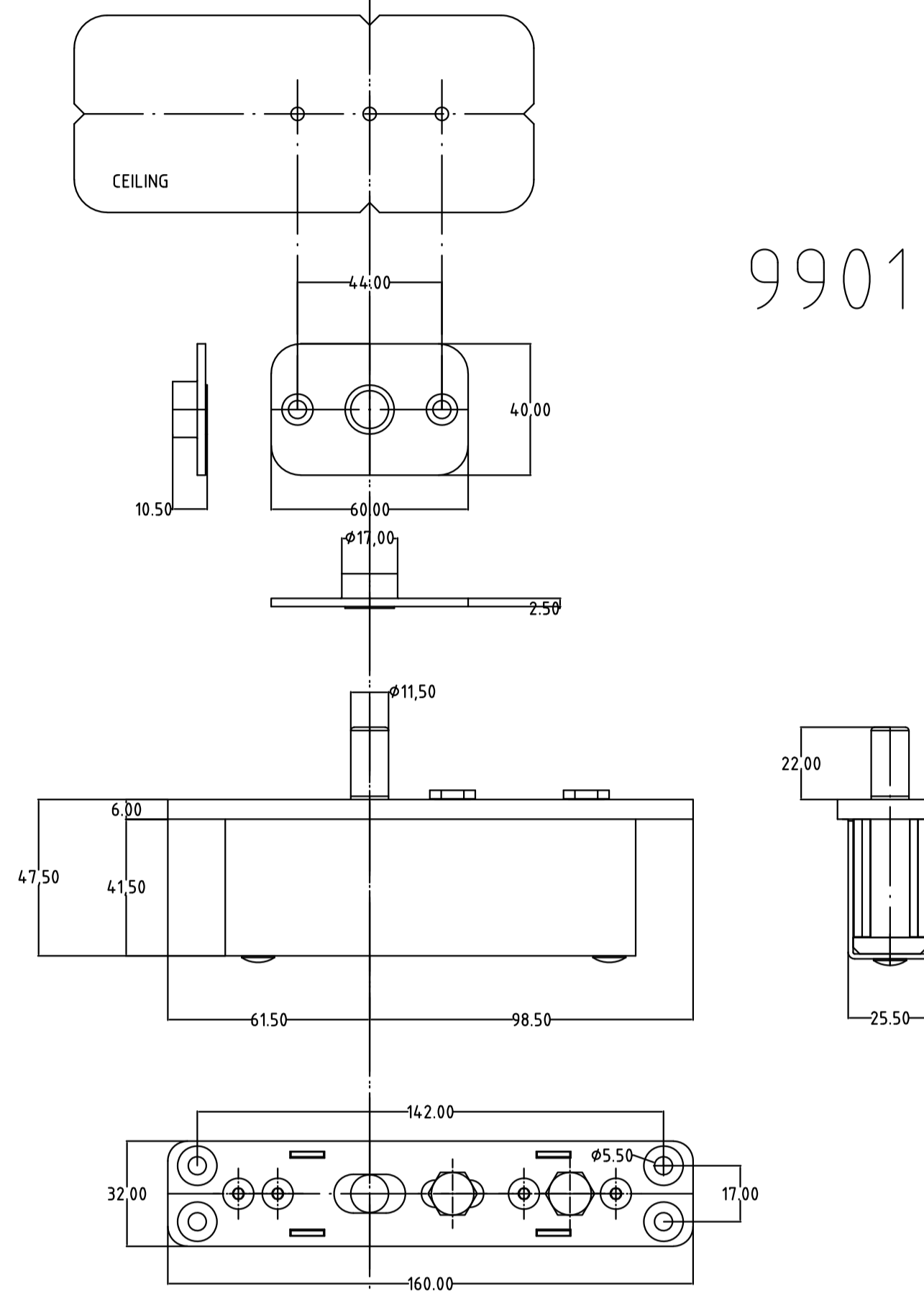

KIT 9903

ASSE DI ROTAZIONE

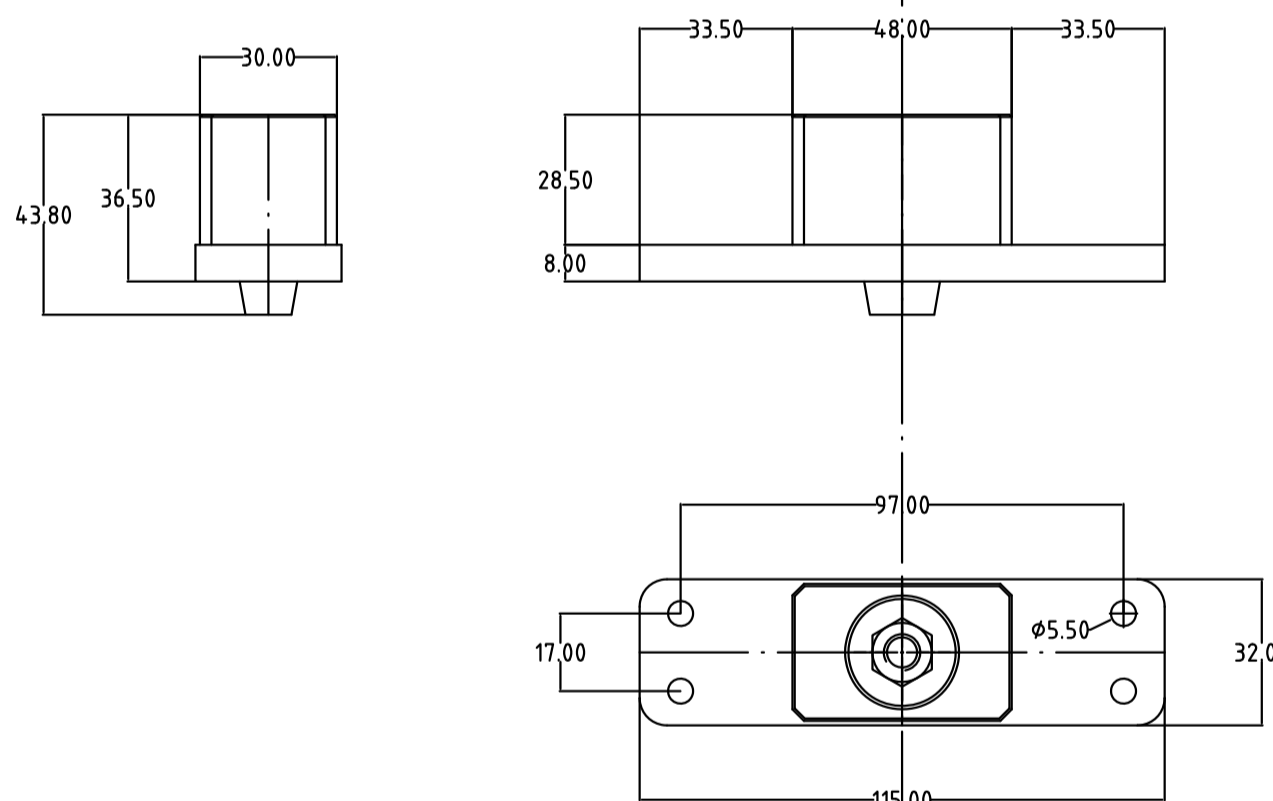

9903 INFERIORE

PIASTRINA MOBILE

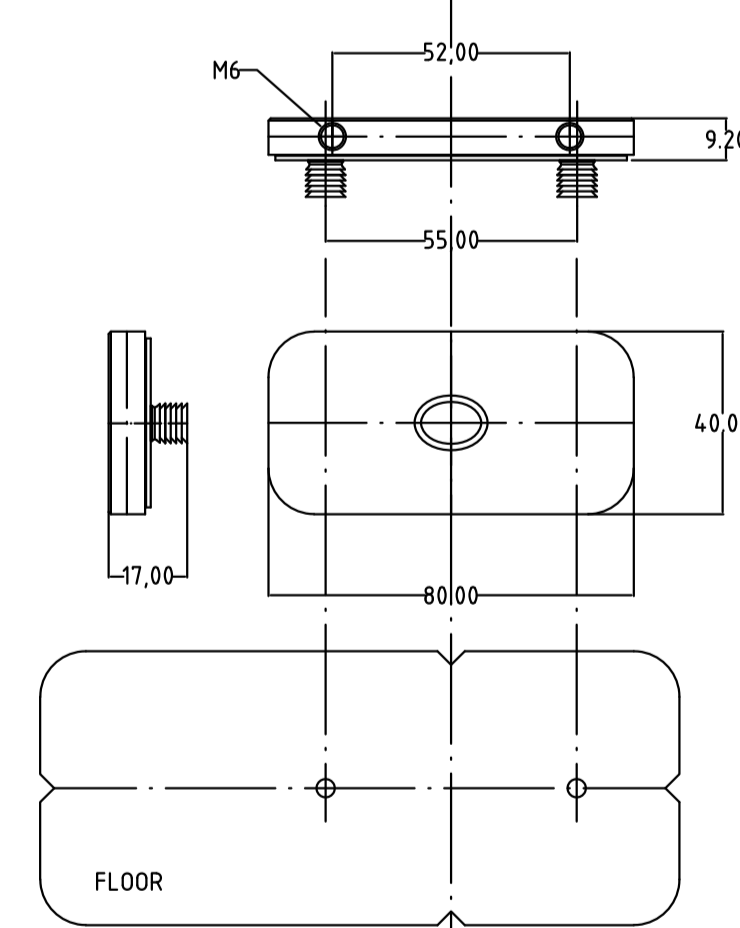

INCASSO CERNIERA INFERIORE

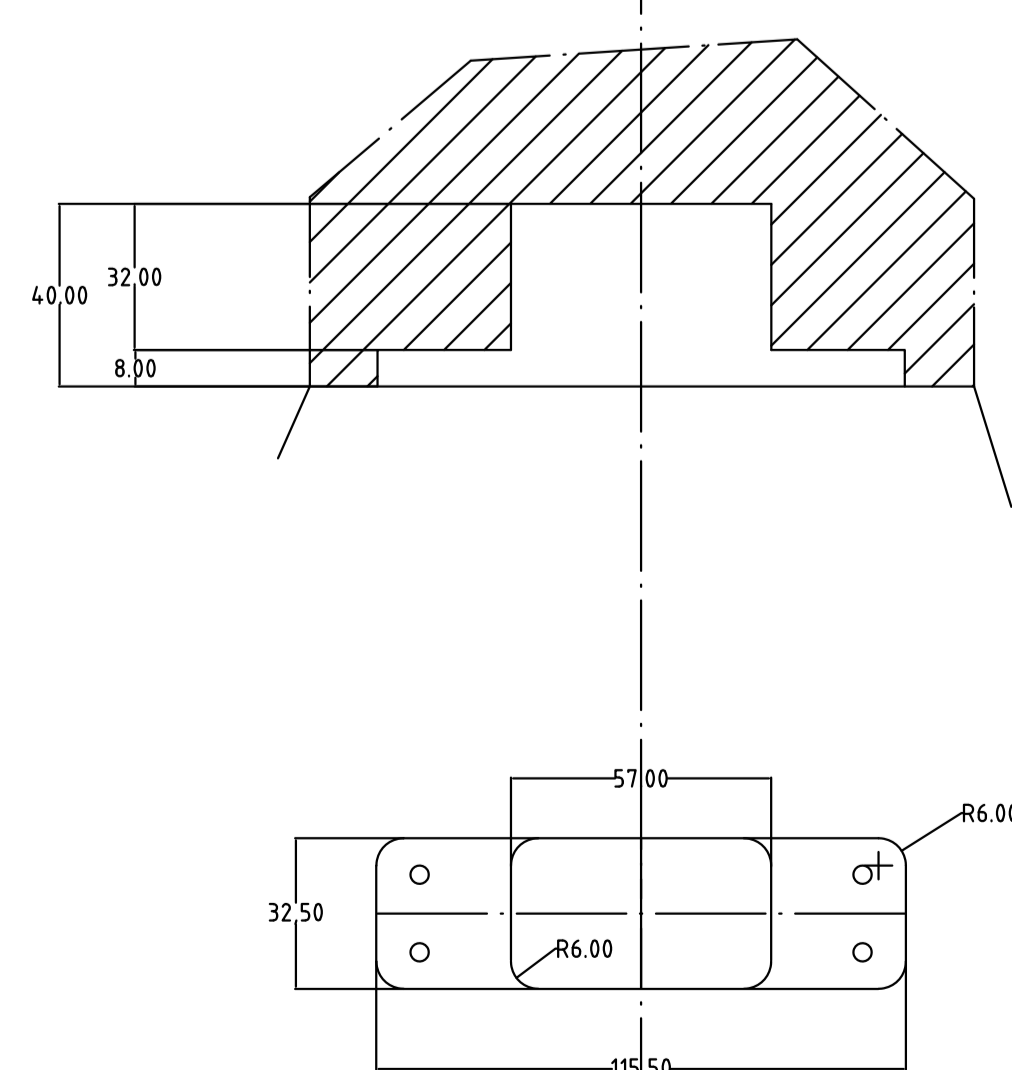

210225830